

### Tools you'll need:

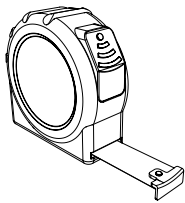

Measuring Tape

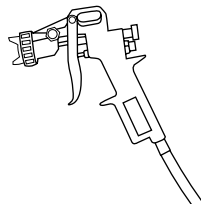

Adhesive

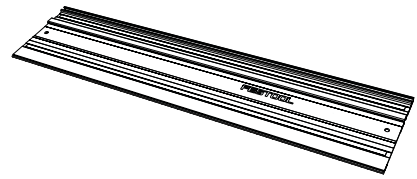

Saw Track and Guide

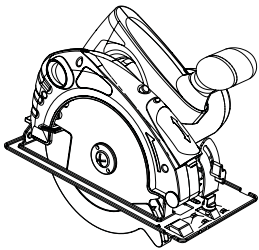

Fine-tooth Blade

or

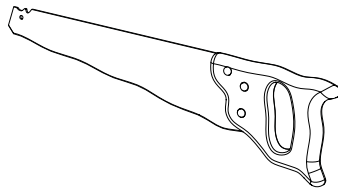

Procut Insulation  
Hand Saw

or

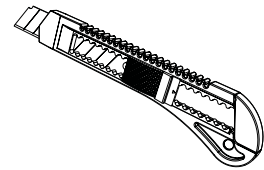

Knife



Pencil

### Handling and Storage

Please read these instructions carefully prior to beginning the installation.

Ensure that you have the planned installation guide from your architect/builder to follow.

When handling, ensure you have clean hands. Alternatively, use clean gloves to reduce markings on light colours.

Always transport and store rolls standing upright - do not transport or store the rolls horizontally as this may crush the nap of the fabric.

Store in a cool, dry place avoiding humidity.

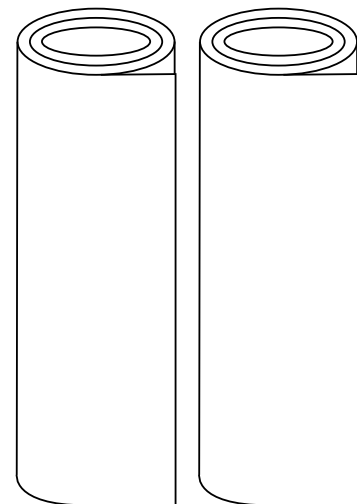

## Before Installation

As dECO Flex is supplied in roll form, ensure the roll is laid flat prior to installation to flatten any curving memory, this will remove any lift when installed.

## Adhesive

dECO products can be direct fixed with Sabregrip S42 Adhesive.

It is the installer's responsibility to ensure adequate substrate preparation and the correct amount of adhesive is applied. Trial the adhesive to check the bond is satisfactory.

Ensuring sufficient bonded surface is critical for achieving a sufficient wet grab strength (initial grab) to hold the dECO product in place whilst the adhesive cures.

Sabre Adhesives recommend a coating weight of 40gms per finished square metre – 20gms on the substrate & 20gms on the product. Please see the SabreGrip spraying manual for more information.

We also recommend a double coat of adhesive on porous substrates, such as unprimed plasterboard.

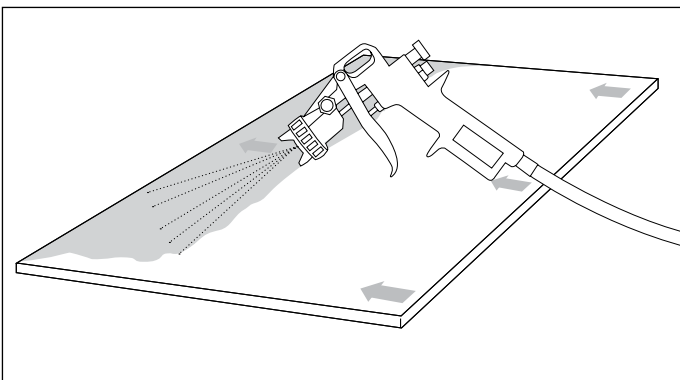

## Cutting dECO Flex

We recommend cutting the product using a saw fitted with a Fine-tooth blade with track and guide, a Procut handsaw or Stanley knife.

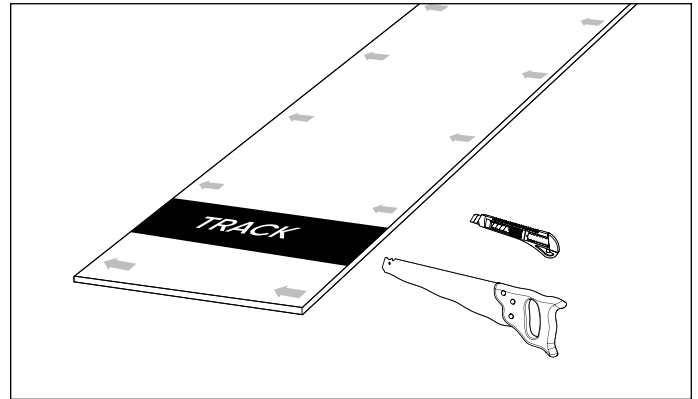

If you are using a blade, ensure the blade is 90 degrees to the surface for square edges, this will achieve the best result on butt joints.

Ensure the blade is sharp and not too long or flexible to avoid skew cuts. Replace the blade often to maintain sharpness. For best results, take care and use multiple cuts & light pressure.

- Keep flat and use a backing mat.
- Use a secure straight edge for straight cuts.

When installing product around internal services, simply cut product and fit around the existing services.

OR

If you need to create holes to insert services, you can use a soldering iron. This will successfully melt holes into polyester acoustic products.

## Installing

### Step 1

Ensure the surface is smooth, dry and free of dust, oil and grease. Plasterboard substrates must be a level 3 or higher finish.

If the product is to be installed on porous surfaces such as un-painted brick or blockwork, then the surface must be primed with a brick or concrete sealer.

Follow the sealer manufacturer's instructions for drying and curing times.

---

### Step 2

Ensure the nap of fabric is running in the same direction.

**NOTE:** there is an arrow on the back of the dECO Flex product, ensure that the arrow is facing up.

---

### Step 3

Cut product to desired size (if applicable), as per cutting instructions on page 2.

---

### Step 4

Apply adhesive to the back of the product - either following the adhesive recommendation on Page 2, or refer to adhesive manufacturer for preferred application and installation technique. Seal substrates and immediately clean off any spills from the visible surfaces.

### Step 5

Press product down flat on wall surface with clean hands or a hand roller to ensure there are no air pockets between the panel and the surface.

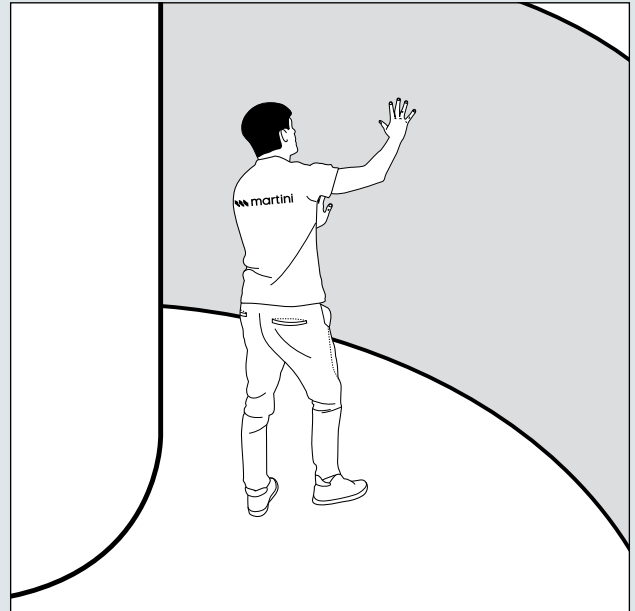

---

### Step 6

Repeat steps for any remaining rolls of product.

---

## Maintenance - Cleaning

- Remove dust with a light vacuum or duster.
- Remove dirt with a soft cloth or sponge
- Always use a soft damp cloth and blot dry.
- For marks or stains, gently clean with De-Solv-It Citrus cleaner to manufacturer's instructions. Blot Dry.
- Test a sample first. For more details, refer to CSR Martini Care & Maintenance Guide.